

# NF12-155

## 12V 155Ah



### Introduction

**E-Guard NF (Front Terminal) series** is designed for telecommunication UPS/EPS system with 12-year design life in float service. The battery features high consistency, excellent performance and reliable standby service life.

### Battery Features

- Compactness
- ETSI 19 inch / 23 inch integration
- Rackable standard component
- High power to volume ratio
- Modularity
- Long life
- Front connection and terminal access
- Central gassing system and hinged front covers on all models
- Fully tank formed plates
- Low impurity electrolyte
- Multi-position usage
- Spill proof / leak proof
- ABS case and cover VO upon request
- Very high purity lead

### Electrical Specification

Design floating Life @ 25°C (77°F)	12 years
Nominal Capacity @ 25°C /77°F	
20 hour rate 10.05A to 1.75Vpc	164 Ah
10 hour rate 19.15A to 1.75Vpc	156.2 Ah

### Internal Resistance

(Fully charged battery @ 25°C /77°F)	5mΩ
Max. Discharge Current @ 25°C /77°F	1240 A (5S)

### Charge Methods: Constant voltage charge @ 25°C /77°F

Cycle Use	14.7 ~ 14.9V
Max. Current	47 A
Standby Use	13.6 - 13.8V

Operating Temperature Range ..... -30 ~ 50°C

Notes: battery voltage must be adjusted according to temperature.

Please refer to our recommendation.

### Self-Discharge

3% of capacity declined per month @ 25°C (77°F).

### Battery Picture & Terminal Layout

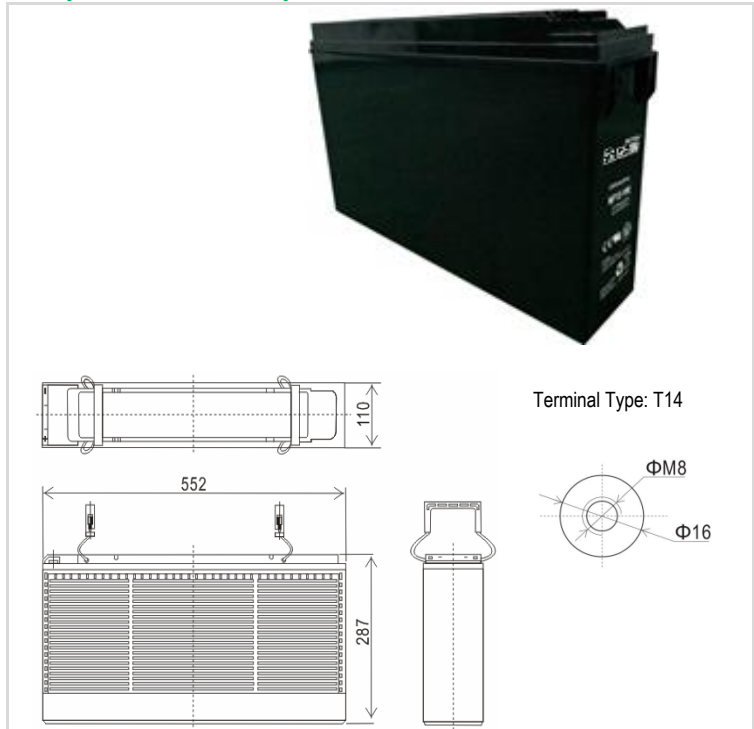

### Dimension & Weight

Dimension (± 2mm)				Weight (± 2%)
Length	Width	Height	Total Height	
552 mm	110 mm	287 mm	287 mm	48.5 kg
21.7 inch	4.3 inch	11.3 inch	11.3 inch	106.9 lbs

### Typical Applications

- Telecommunications
- Power Utility
- Data Center
- UPS & EPS

### Certificates



### Constant Current Discharge (Amperes @ 25°C /77°F)

V/cell	10min	15min	20min	25min	30min	35min	40min	45min	50min	55min	1hr	2hr	3hr	4hr	5hr	10hr	20hr
1.60	391.8	301.4	253.2	216.5	185.0	163.7	144.9	130.5	120.9	102.7	66.5	46.64	36.96	30.47	19.48	15.93	8.35
1.65	372.6	286.6	240.8	205.9	175.9	155.7	137.8	124.1	114.9	97.6	65.2	45.88	36.27	29.86	19.39	15.93	8.35
1.70	360.9	277.6	233.3	199.4	170.4	150.8	133.5	120.2	111.3	94.6	63.9	44.96	35.51	29.25	19.16	15.78	8.27
1.75	349.2	268.6	225.7	192.9	164.9	145.9	129.2	116.4	107.7	91.5	62.5	44.04	34.74	28.63	18.81	15.62	8.20
1.80	328.2	252.5	217.7	186.0	158.9	137.2	121.4	109.4	101.3	86.0	61.0	43.12	33.90	27.87	18.58	15.50	8.04

### Constant Power Discharge (Watts/cell @ 25°C /77°F)

V/cell	10min	15min	20min	25min	30min	35min	40min	45min	50min	1hr	2hr	3hr	4hr	5hr	8hr	10hr	20hr
1.60	669.9	515.3	433.1	370.1	318.2	284.1	253.7	234.9	221.6	201.0	120.8	86.71	69.92	57.78	36.63	31.54	16.52
1.65	637.1	490.1	411.8	352.0	302.6	270.2	241.2	223.4	210.7	191.1	117.3	85.94	69.31	57.32	37.61	31.54	16.53
1.70	617.2	474.7	398.9	341.0	293.1	261.7	233.7	216.4	204.1	185.1	114.6	85.18	68.69	56.86	36.60	31.24	16.38
1.75	597.2	459.4	386.0	329.9	283.6	255.5	228.2	211.3	199.3	180.8	111.0	84.26	68.00	56.40	36.31	30.94	16.24
1.80	584.2	449.4	385.2	318.1	266.6	240.2	214.4	198.6	187.3	172.4	107.5	83.49	67.39	55.94	35.34	30.64	16.08

Subject to revision without notice. Please contact our sales representatives for latest version.

Web: [www.enervision.co.za](http://www.enervision.co.za) | Email: [sales01@enervision.co.za](mailto:sales01@enervision.co.za) | Telephone: 0861 111 270

VERSION:20180522



# NF12-155

## 12V 155Ah



### Graphs

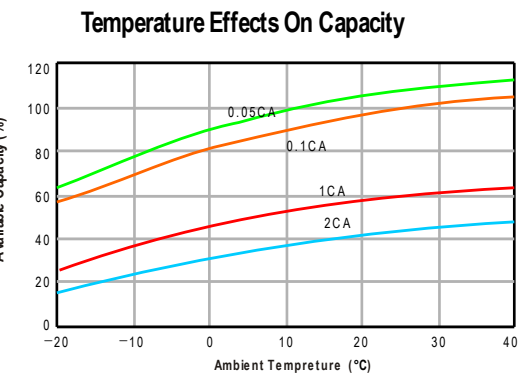
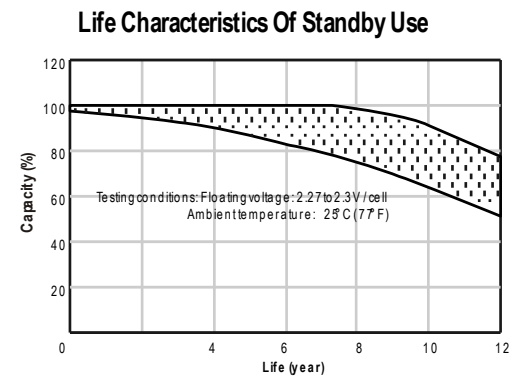
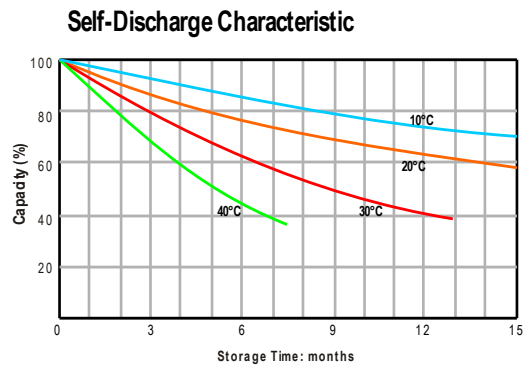
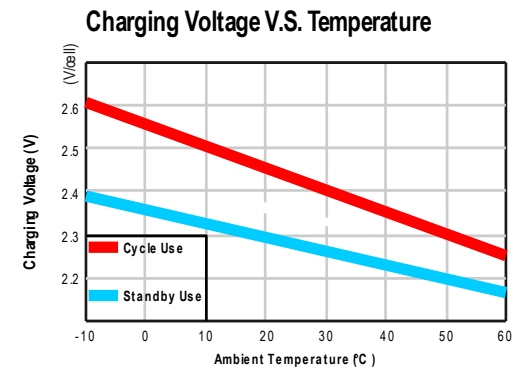
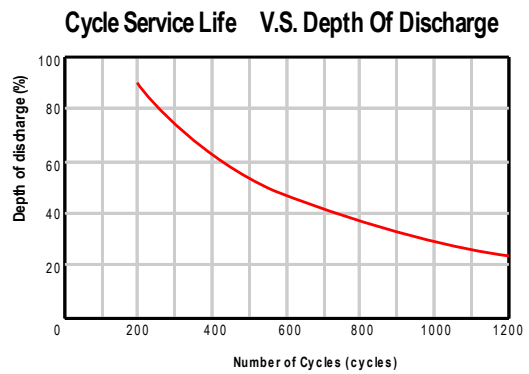
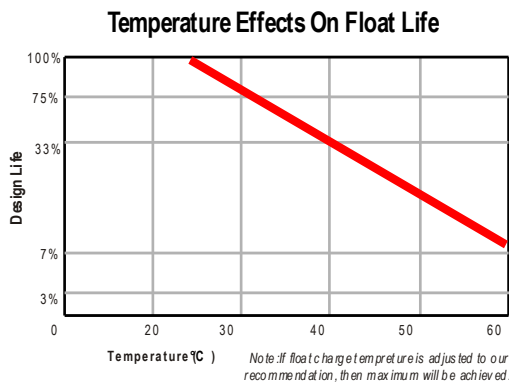
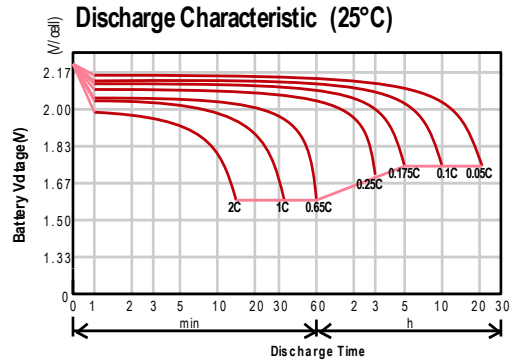
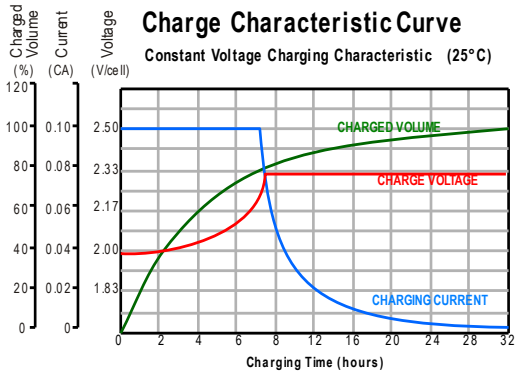

Subject to revision without notice. Please contact our sales representatives for latest version.

Web: [www.enervision.co.za](http://www.enervision.co.za) | Email: [sales01@enervision.co.za](mailto:sales01@enervision.co.za) | Telephone: 0861 111 270

VERSION:20180522